

KONTUR INSTALLATION INSTRUCTIONS

STEP 1 - Installing Supports

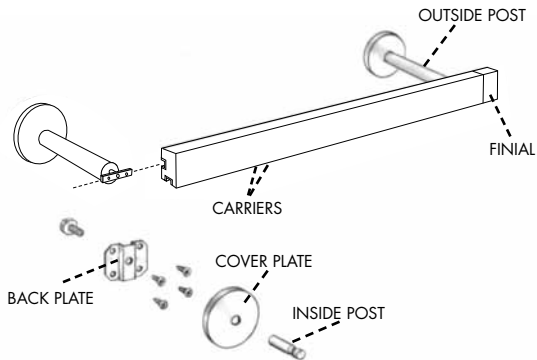

Height calculation for regular clips.

Add 1 1/8" to length of drapes, plus at least 1/2" clearance from the floor. This measurement is the distance from floor to center point of Back Plate. **Please note drapes should not touch rail, install pin on hooks with this in consideration.**

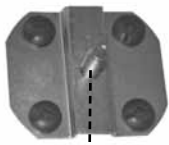

1. Install Back Plate to wall. Make sure all M-6 bolts are level. If you have a spliced track the Center Support must be installed at the position of splice.
2. Cover Back Plate with Cover Plate.
3. Screw on Inside Post very securely. Do not leave any play.

STEP 2 - Splice track if necessary

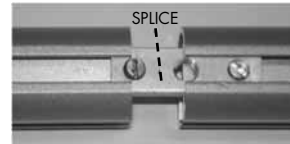

1. Join the track sections together.

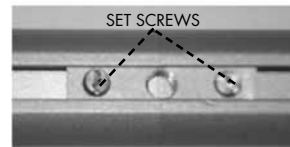

2. Tighten set screws.

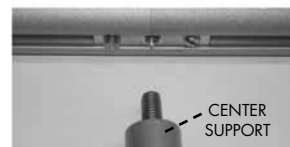

3. Screw Center Support directly into center hole of Splice.



4. Cover splice with Splice Cap after installation is complete.

STEP 3 - Installing Outside Posts



1. Loosen all screws on Outside Posts.
2. Slide Outside Posts into back channel of Rail.
3. Align Outside Posts with Inside Posts from **Step 1**.

STEP 4 - Mount rail onto supports



1. Slide Outside Posts over Inside Posts.
2. Once all Outside Posts including Center Supports are in place, tighten posts securely by turning clockwise.
3. Tighten set screws.
4. Finished result for Center Supports.
5. Finished result for side posts.

Step 5 - Hand draw system

1. Install Endcaps and then click in carriers.
2. Attach baton to side of drape you wish to operate from by clipping it into the first carrier.
3. Use plastic plug to lock last carries into place so end of drape dose not move then the drape is fully closed.

Step 6 - Cord draw system

1. Install Endcaps and then click in carriers.
2. For **center opening tracks greater than 84"**, click in plastic plug at center point of rail.

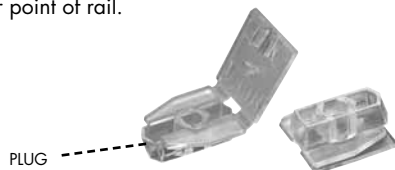

STEP 6 - Cord Draw Systems, Installing Pulley

1. Attach pulley to cord. Stretch pulley until cord is tight. It is not necessary to use excessive tension. Mark spot with pencil on wall or floor. Remove cords and install pulley then re-install cords.

- **THE PULLEY MUST BE INSTALLED. IT IS THE LAW. FAILURE TO DO SO CAN RESULT IN INJURY TO CHILDREN OR PETS!**

2. IF NEEDED - To adjust CONTROL cord drop, pull cord through master carrier until pulley is at desired height. Pull cord an extra few inches and knot cord at proper spot. When you install the pulley the cord will slide back into place.



INSTALLATION D'UNE MISE À JOUR EURO-SCOPE KONTUR, NEXGEN, TEKNO 25, TEKNO 40

ÉTAPE 1 - Assemblage du rail lorsque le splice est inclus

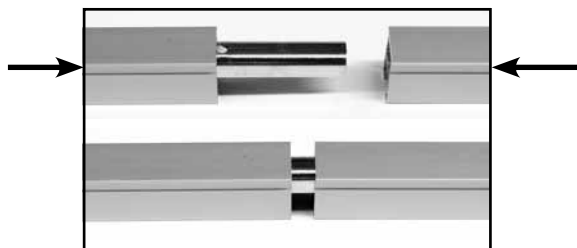

ÉTAPE 2 - Installing mounting hardware

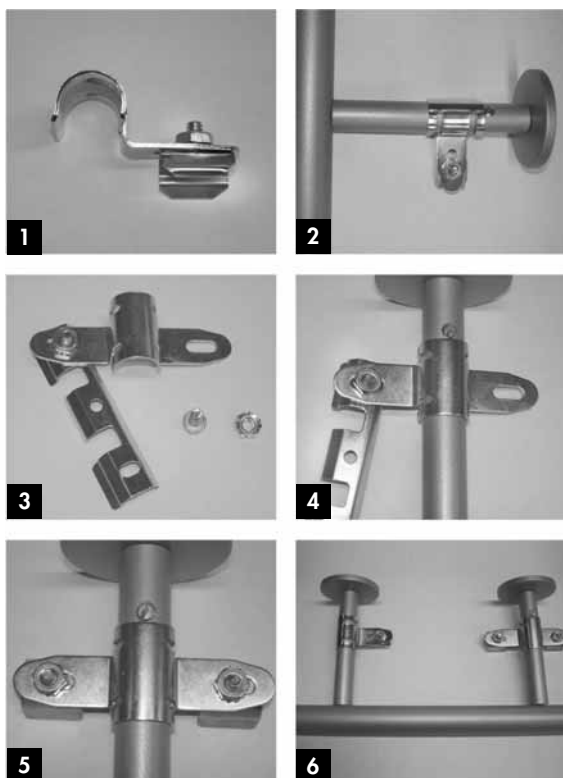

1. Assemblez les attaches « assemblées » des tiges extérieures.
2. Attachez les attaches « assemblées » sur les tiges extérieures.
3. Assemblez partiellement l'attache "mise à jour" de la tige centrale.
4. Montez l'attache « centrale » sur la tige centrale et complétez l'assemblage de l'attache.
5. Aperçu de l'attache centrale complétée.
6. Toutes les attaches doivent être alignées pour l'installation du rail.

ÉTAPE 3 - L'installation du rail



1. Installez les embouts et insérez suite les glissière dans le rail.
2. Attachez le lance-rideau à la première glissière sur le côté désiré (ouverture à gauche ou à droite manuelle).

ÉTAPE 4 - Installation de la poulie

1. Déterminez si la corde sera du même côté que le lance-rideau. Le côté du contrôle peut être changé en tirant la corde à travers le contrôle du côté opposé.
 2. **Pour rails avec ouverture centrale seulement.** Insérez le bouchon de plastique au milieu du rail. Ce bouchon soutiendra la corde lors de l'installation de la poulie.
 3. Attachez les cordes à la poulie. Tirez la poulie pour créer suffisamment de tension. Marquez le point sur le mur ou le plancher avec un crayon.
 4. Enlevez les cordes et attachez la poulie au mur ou au placher. Installez de nouveau les cordes.
- **La poulie doit être installée. C'est la loi. Ne pas s'y conformer peut entraîner des blessures aux enfants ou aux animaux familiers.**

